

537. EXTENDED CONTINUOUS LOGIC AND THE THEORY
OF COMPLEX CRITERIA*

Jozo J. Dujmović

Proposed in this paper is extended continuous logic (ECL), a generalization of continuous logic based on the introduction of variable degree of conjunction and disjunction in complex conjunctive and disjunctive statements. The properties of ECL, as an algebraic structure, are analysed and various ECL functions are defined and classified.

The apparatus of sentential algebra in ECL is defined with the objective to develop a theory of complex criteria as a separate branch of continuous logic. The basic concept was that the central problem of criteria theory is the simulation and formalisation of the human reasoning process in the intuitive synthesis of complex criteria.

Possible applications of criteria theory are numerous, but of special interest is the solution to the problem of evaluation and comparison of various complex systems. For this purpose an algorithm for synthesizing effectiveness criteria of complex systems is proposed. The algorithm represents a general theoretical model of arbitrary complex criterion.

1. GENERAL MODEL OF COMPLEX CRITERIA AND THE SYSTEM
EVALUATION PROCESS

Let S be a given system which performs an arbitrary mapping of the set of inputs into the set of outputs. Furthermore, let

$$x = (x_1, \dots, x_n), \quad x_i \in \mathbf{R}_i, \quad \mathbf{R}_i \subset \mathbf{R}, \quad i = 1, \dots, n$$

be a given sequence of real numbers which represent system performance indicators and reflect the ability of a system to attain some desired objectives. We shall call the quantities x_1, \dots, x_n „components for evaluation”.

Definition 1. *The elementary effectiveness criteria for the system S are the mappings $g_i: \mathbf{R}_i \rightarrow I$, $i = 1, \dots, n$, $I: = [0, 1]$. The quantity $E_i = g_i(x_i)$ is called the i -th elementary effectiveness of the system S and represents the degree of truth in the statement „the value of the component for evaluation x_i completely fulfils the requirements of the i -th elementary criterion”. We shall call the interval I the effectiveness interval.*

Definition 2. *The global effectiveness criterion of the system S is the mapping $g: \mathbf{R}_1 \times \mathbf{R}_2 \times \dots \times \mathbf{R}_n \rightarrow I$, where the quantity $E = g(x_1, \dots, x_n)$ is called the global system effectiveness and it represents the degree of truth in the statement „system S completely fulfils all given requirements”.*

Definition 3. *Under the „evaluation of a system S ” we shall consider the three-stage process where elementary criteria g_1, \dots, g_n are defined in the first stage,*

* Presented June 8, 1975 by V. DEVIDÉ.

complex criterion g is synthesized in the second stage and the global effectiveness E of the given system, on the basis of particular values of the components for evaluation x , is calculated in the stage three.

When constructing the mapping g the most natural approach is to adopt for g to be a formal model which best describes the human reasoning process during the evaluation of a system on the basis of intuitively formed complex criteria. For this purpose the following dominant components in the mental processes of synthesis of complex criteria and evaluation can be singled out:

- complex criteria decompose into a sequence of independent elementary criteria
- elementary criteria are evaluated individually, i.e. the elementary effectivenesses are individually determined
- the global system effectiveness is determined by appropriate operations performed over the calculated elementary effectivenesses

the global effectiveness of the system is not greater then the largest nor lesser than the smallest of the elementary effectivenesses.

The general formal model of a complex criterion based on the simulation of the described mental process is shown in Fig. 1.

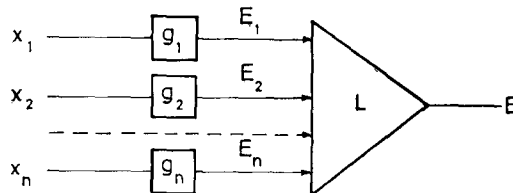

Fig. 1

The mapping $L: I^n \rightarrow I$ plays a fundamental part in this model, which due to its nature must be realized through sentential algebra. However, the apparatus of sentential algebra in continuous logic is inadequate for determining in a suitable manner the global effectiveness $E = L(E_1, \dots, E_n)$ starting from elementary effectivenesses. The necessary extensions of sentential algebra in continuous logic are described in the following text.

2. A GENERALIZATION OF SENTENTIAL ALGEBRA FOR SYNTHESIZING COMPLEX CRITERIA

In the process of synthesizing complex criteria it is necessary to extend the apparatus of sentential algebra in continuous logic with two new degrees of freedom. These are:

- continuously variable degrees of conjunctivity and disjunctivity in complex conjunctive and disjunctive statements, and
- a continuously variable degree of relative significance of each elementary statement with respect to a complex statement formed from given elementary statements.

The need for these generalizations is evident in practically all problems concerning the synthesis of complex criteria. For example, consider the simplest case, a complex criterion consisting of two elementary criteria which results in

the sentential relationship $E = L(E_1, E_2)$. Let us assume that $E_1 < E_2$ and that complex criterion is fulfilled when both elementary criteria are simultaneously fulfilled. If the only functions available for a formal description of the complex criterion are \min , \max and $x \mapsto 1 - x$, then according to the requirements of the complex criterion it follows that $E = \min(E_1, E_2) = E_1$. This leads to a situation in which the global system effectiveness is insensitive to the elementary effectiveness E_2 , i. e. $\frac{\partial E}{\partial E_2} = 0$, as long as $E_1 < E_2$, which in turn implies that the cases $E_{\min} = E_1 = E_2$ and $E_{\min} = E_1 < E_2$ ($0 \leq E_{\min} < 1$) are mutually equivalent. However, the quantity E_2 shows to what extent one of the criteria (perhaps even the dominant one) is fulfilled and in majority of real situations it is not quite irrelevant whether that part is fulfilled to a greater or lesser degree. Generally, an increase in the degree of fulfilment of one part of a complex criterion automatically means an increase in the degree of fulfilment of the complex criterion as a whole, i. e. $\frac{\partial E}{\partial E_1}, \frac{\partial E}{\partial E_2} > 0$, so that in the general case, the situations $E_1 = E_2$ and $E_1 < E_2$ should not be equivalent. Problems of this type require that the degree of coincidence in fulfilling elementary criteria should be realized as a continuously adjustable quantity.

Let us consider the same complex criterion in a situation when $E_1, E_2 \in \{E_{\min}, E_{\max}\}$, $0 \leq E_{\min} < E_{\max} \leq 1$. If once again we restrict ourselves only to the functions \min , \max and $x \mapsto 1 - x$, it follows that the cases $E_1 = E_{\min}$, $E_2 = E_{\max}$ and $E_1 = E_{\max}$, $E_2 = E_{\min}$ are mutually equivalent. However, generally E_1 and E_2 can be associated (according to their significance) with dimensionally very diverse components of a complex criterion, so that despite the urge to fulfil both elementary criteria simultaneously it is relevant whether the greater or lesser part of the complex criterion is fulfilled to a greater extent. Therefore, the cases $E_1 = E_{\min}$, $E_2 = E_{\max}$ and $E_1 = E_{\max}$, $E_2 = E_{\min}$ cannot generally be equivalent. This leads to the need to include appropriately into sentential algebra the possibility that within the confines of every complex statement elementary statements can be discriminated according to the degree of relative significance.

This continuous logic, within which sentential algebra has such properties, we shall call „extended continuous logic” (ECL). ECL represents a generalization of continuous logic obtained by appropriately replacing conjunctions and disjunctions in sentential algebra with quasi-conjunctions and quasi-disjunctions described in the sequel.

3. QUASI-CONJUNCTION AND QUASI-DISJUNCTION

Let $t = (t_1, \dots, t_n)$ be a sequence of degrees of truth of a statements in continuous logic ($t_i \in I$, $i = 1, \dots, n$). Starting from power means and weighted power means [1]

$$(1) \quad M_n^{[r]}(t) := \lim_{s \rightarrow r} \left(\frac{1}{n} \sum_{i=1}^n t_i^s \right)^{1/s},$$

$$M_n^{[r]}(t; W) := \lim_{s \rightarrow r} \left(\sum_{i=1}^n W_i t_i^s \right)^{1/s},$$

$$W = (W_1, \dots, W_n), \quad 0 < W_i < 1, \quad i = 1, \dots, n, \quad \sum_{i=1}^n W_i = 1, \quad r \in \mathbf{R}_\infty$$

in reference [2] the weighted conjunctive and disjunctive means are defined by

$$(2) \quad L_n^{[c]}(t; W) := M_n^{[C_n^{-1}(c)]}(t; W)$$

$$N_n^{[d]}(t; W) := M_n^{[D_n^{-1}(d)]}(t; W),$$

respectively, where functions $C_n^{-1}, D_n^{-1}: I \rightarrow \mathbf{R}_\infty$ are inverse to the functions

$$(3) \quad C_n(r) := \frac{n-(n+1)\overline{M}_n^{[r]}}{n-1}$$

$$D_n(r) := \frac{(n+1)\overline{M}_n^{[r]}-1}{n-1},$$

$$\overline{M}_n^{[r]} := \int_0^1 dt_1 \cdots \int_0^1 M_n^{[r]}(t) dt_n, \quad n > 1.$$

The functions $d \mapsto D_n^{-1}(d)$ for $n=2, 3, 4, 5$ are shown in Fig. 2.

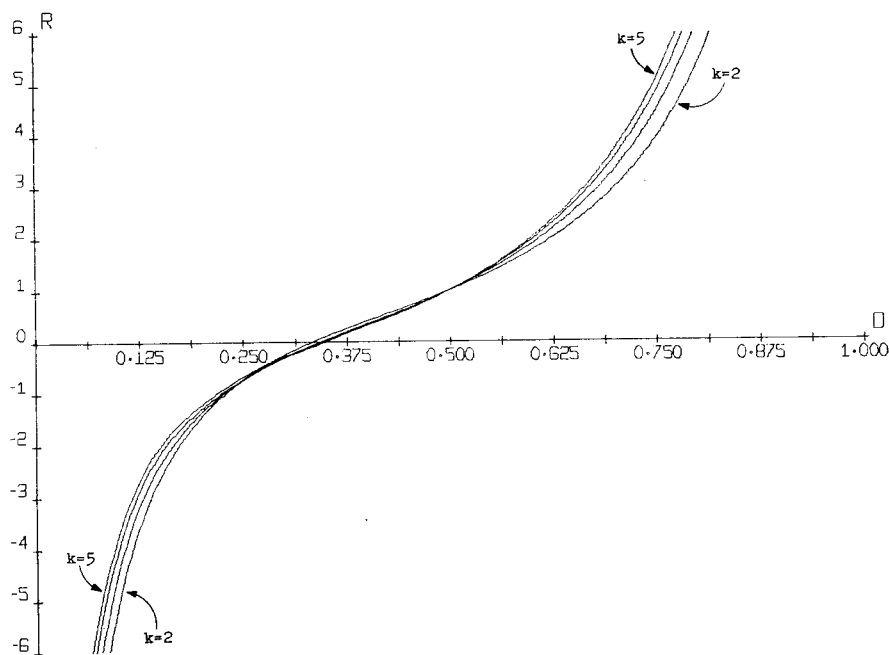

Fig. 2

Quantities $c = C_n(r)$ and $d = D_n(r)$ are called the conjunction and the disjunction degree respectively. From [3] and (3) it follows that

$$(4) \quad \frac{1}{n+1} \leq \overline{M}_n^{[r]} \leq \frac{n}{n+1}, \quad 0 \leq C_n(r), D_n(r) \leq 1, \quad C_n(r) + D_n(r) = 1.$$

For the conjunction and disjunction degrees

$$c, d \in \lambda, \quad \lambda := \{0, 0.0625, 0.125, \dots, 1\}$$

seventeen basic logic operations are defined as shown in Table 1.

Table 1.

BASIC LOGIC OPERATIONS IN EXTENDED CONTINUOUS LOGIC

NAME OF OPERATION	SYMBOL OF OPERATION	CONJUNCTION DEGREE	DISJUNCTION DEGREE	PARAMETER OF THE WEIGHTED POWER MEAN (r)			
				N=2	N=3	N=4	N=5
CONJUNCTION	C	1.0000	0.0000	MINUS INFINITY			
STRONG QUASI-CONJUNCTION(+)	C+	0.9375	0.0625	-9.0600	-7.6393	-6.7100	-6.2723
STRONG QUASI-CONJUNCTION	C+	0.8750	0.1250	-3.5100	-3.1131	-2.8232	-2.6404
STRONG QUASI-CONJUNCTION(-)	C++	0.8125	0.1875	-1.6548	-1.5493	-1.4519	-1.3627
MEDIUM QUASI-CONJUNCTION	CA	0.7500	0.2500	-0.7203	-0.7314	-0.7145	-0.6697
WEAK QUASI-CONJUNCTION(+)	C+	0.6875	0.3125	-0.1478	-0.2055	-0.2248	-0.2025
WEAK QUASI-CONJUNCTION	C-	0.6250	0.3750	0.2612	0.1953	0.1678	0.1787
WEAK QUASI-CONJUNCTION(-)	C--	0.5625	0.4375	0.6194	0.5730	0.5473	0.5423
CONJUNCTIVE-DISJUNCTIVE UNDETERMINATION	A	0.5000	0.5000	1.0000	1.0000	1.0000	1.0000
WEAK QUASI-DISJUNCTION(-)	D--	0.4375	0.5625	1.4490	1.5190	1.5639	1.5836
WEAK QUASI-DISJUNCTION	D-	0.3750	0.6250	2.0185	2.1879	2.3019	2.3624
WEAK QUASI-DISJUNCTION(+)	D++	0.3125	0.6875	2.7917	3.1011	3.3181	3.4427
MEDIUM QUASI-DISJUNCTION	DA	0.2500	0.7500	3.9293	4.4501	4.8250	5.0342
STRONG QUASI-DISJUNCTION(-)	D+-	0.1875	0.8125	5.8023	6.6748	7.3171	7.7294
STRONG QUASI-DISJUNCTION	D+	0.1250	0.8750	9.5207	11.0948	12.2766	13.0662
STRONG QUASI-DISJUNCTION(+)	D++	0.0625	0.9375	20.6303	24.3177	27.1346	29.0810
DISJUNCTION	D	0.0000	1.0000	PLUS INFINITY			

Operations $L_n^{[c]}(t; W)$, $N_n^{[d]}(t; W)$ and $M_n^{[r]}(t; W)$ for $1/2 < c < 1$, $0 < d < 1/2$ ($c, d \in \lambda$) and $r < 1$ are called quasi-conjunctions (QC), and for $0 < c < 1/2$, $1/2 < d < 1$ ($c, d \in \lambda$) and $r > 1$ quasi-disjunctions (QD). According to Table 1 various intensities of quasi-conjunction will be denoted by C^{--} , C^- , C^+ , CA , C^{+-} , C^+ and C^{++} , and various quasi-disjunction intensities by D^{--} , D^- , D^+ , DA , D^{+-} , D^+ and D^{++} . The parameter r used in the weighted power means which correspond to quasi-conjunctions and quasi-disjunctions is determined on the basis of the desired conjunction (disjunction) degree. From Table 1 it follows that for a constant conjunction (disjunction) degree the value of r depends on the number of variables n , so that is suitable to indicate this with an appropriate subscript:

$$r_n := D_n^{-1}(d) = C_n^{-1}(1-d).$$

Furthermore, for every $r_n \in \mathbf{R}_\infty (n > 1)$ the inverse parameter of power means $\bar{r}_n \in \mathbf{R}_\infty$ is defined:

$$(5) \quad \bar{r}_n := C_n^{-1}(1 - C_n(r_n)) = D_n^{-1}(1 - D_n(r_n))$$

and from (3), (4) and (5) it is easily shown that

$$(6) \quad C_n(\bar{r}_n) = D_n(r_n), \quad D_n(\bar{r}_n) = C_n(r_n), \quad \bar{M}_n^{[r_n]} + \bar{M}_n^{[\bar{r}_n]} = 1.$$

It is useful to introduce the following notation for the operations of quasi-conjunction, quasi-disjunction and negation:

$$(7) \quad W_1 t_1 \Delta^c W_2 t_2 \Delta^c \cdots \Delta^c W_n t_n := L_n^{[c]}(t; W) = N_n^{[d]}(t; W) = M_n^{[r]}(t; W)$$

$$(c > 1/2, \quad d = 1 - c, \quad r = C_n^{-1}(c)),$$

$$W_1 t_1 \nabla^d W_2 t_2 \nabla^d \cdots \nabla^d W_n t_n := L_n^{[c]}(t; W) = N_n^{[d]}(t; W) = M_n^{[r]}(t; W)$$

$$(d > 1/2, \quad c = 1 - d, \quad r = D_n^{-1}(d))$$

$$t_i' := 1 - t_i, \quad t_i \in I, \quad i = 1, \dots, n.$$

Notation (7) represents the convention that the symbol Δ^c is reserved for *QC* and the symbol ∇^d for *QD*. However, whenever it is necessary, it is possible to revoke this convention since $\Delta^a \equiv \nabla^{1-a}$, $a \in I$. In cases where it is obvious from the context, quantities c and d can be left out in the symbols Δ^c and ∇^d . In addition, when both Δ and ∇ are used in the same expression, it is assumed that $\Delta = \Delta^a$, $\nabla = \nabla^a$, $a \in I$, i. e. if the weighted power mean parameter r_n is used for Δ , then r_n is used for ∇ .

4. BASIC LAWS OF EXTENDED CONTINUOUS LOGIC

ECL is an algebraic system consisting of the set of real numbers I , the binary operations Δ^c and ∇^d and the unary operation $'$. Since from (7) and [2] the following holds

$$W_1 t_1 \Delta^1 \cdots \Delta^1 W_n t_n = t_1 \wedge \cdots \wedge t_n := \min(t_1, \dots, t_n),$$

$$W_1 t_1 \nabla^1 \cdots \nabla^1 W_n t_n = t_1 \vee \cdots \vee t_n := \max(t_1, \dots, t_n)$$

$$(\Delta^1 \equiv \nabla^0 \equiv \wedge, \quad \nabla^1 \equiv \Delta^0 \equiv \vee),$$

ECL is, in case of extreme values of the conjunction and disjunction degrees, reduced to classical continuous logic [4, 5]. If $0 < c, d < 1$, the laws of *ECL* differ from the laws of classical continuous logic. In this section we shall analyse the manner in which the basic *ECL* operations quasi-conjunction, quasi-disjunction and negation fulfil the basic laws in algebraic systems [6, 7].

1. *Associativity*. For degrees of truth $t_1, t_2, t_3 \in I$ and weights $a_1, a_2, b_1, b_2 \in I$ ($a_1 + b_1 = a_2 + b_2 = 1$) the following associations hold:

$$(8) \quad a_1 t_1 \Delta b_1 (a_2 t_2 \Delta b_2 t_3) = (a_1 + b_1 a_2) \left(\frac{a_1}{a_1 + b_1 a_2} t_1 \Delta \frac{b_1 a_2}{a_1 + b_1 a_2} t_2 \right) \Delta b_1 b_2 t_3,$$

$$a_1 t_1 \nabla b_1 (a_2 t_2 \nabla b_2 t_3) = (a_1 + b_1 a_2) \left(\frac{a_1}{a_1 + b_1 a_2} t_1 \nabla \frac{b_1 a_2}{a_1 + b_1 a_2} t_2 \right) \nabla b_1 b_2 t_3.$$

Proof. From (7) and (1) and by developing the left-hand side of the first relationship in (8) it follows that

$$(9) \quad a_1 t_1 \Delta^{c_2} b_1 (a_2 t_2 \Delta^{c_2} b_2 t_3) = (a_1 t_1^{r_2} + b_1 a_2 t_2^{r_2} + b_1 b_2 t_3^{r_2})^{1/r_2}, \quad r_2 = C_2^{-1}(c_2)$$

$$= a_1 t_1 \Delta^{c_3} b_1 a_2 t_2 \Delta^{c_3} b_1 b_2 t_3, \quad c_3 = C_3(r_2)$$

By developing the right-hand side the same expression is derived. The proof of the other relation in (8) is analogous, *QED*.

The law of associativity (8) can be generalized to the case of associative structures which can be represented as „*m*-ary trees” in which the same number of branches flow into every vertex (the branches represent the weights and the vertices identical operators, Δ or ∇). In a similar way as in relationship (9), each *m*-ary tree with operations Δ^c yields the expression

$$(W_1 t_1^{r_m} + \dots + W_n t_n^{r_m})^{1/r_m}, \quad r_m = C_m^{-1}(c), \quad \text{where } W_i (i \in \{1, \dots, n\})$$

represents the product of weights along the path from the root of the tree to the *i*-th peripheral vertex. Therefore, the generalized law of associativity can be formulated as follows: two arbitrary *m*-ary associative structures with the same number of peripheral vertices are equal if for all peripheral vertices they have equal weight products along paths leading from the root of the tree to the corresponding peripheral vertices.

EXAMPLE. The two binary associative structures of types „2+2” and „2+1+1” shown in Fig. 3 are equal. Indeed, from (8) and (9) it follows that

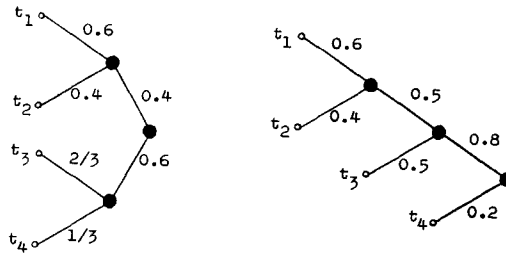

Fig. 3

$$\begin{aligned} & 0.4(0.6 t_1 \Delta^{c_2} 0.4 t_2) \Delta^{c_2} 0.6 \left(\frac{2}{3} t_3 \Delta^{c_2} \frac{1}{3} t_4 \right) \\ &= 0.8(0.5(0.6 t_1 \Delta^{c_2} 0.4 t_2) \Delta^{c_2} 0.5 t_3) \Delta^{c_2} 0.2 t_4 \\ &= 0.24 t_1 \Delta^{c_4} 0.16 t_2 \Delta^{c_4} 0.4 t_3 \Delta^{c_4} 0.2 t_4, \quad c_4 = C_4(C_2^{-1}(c_2)). \end{aligned}$$

Starting from (9) the associative law can be written in the following form

$$\begin{aligned} (10) \quad W_1 t_1 \Delta^{c_3} W_2 t_2 \Delta^{c_3} W_3 t_3 &= W_1 t_1 \Delta^{c_2} (W_2 + W_3) \left(\frac{W_2}{W_2 + W_3} t_2 \Delta^{c_2} \frac{W_3}{W_2 + W_3} t_3 \right) \\ &= (W_1 + W_2) \left(\frac{W_1}{W_1 + W_2} t_1 \Delta^{c_2} \frac{W_2}{W_1 + W_2} t_2 \right) \Delta^{c_2} W_3 t_3, \\ C_2^{-1}(c_2) &= C_3^{-1}(c_3), \end{aligned}$$

which means that in the general case $c_2 \neq c_3$ even though the difference $|c_2 - c_3|$ is small according to Fig. 2. Therefore, the associative law (9) and (10) is only approximately valid within the bounds of the same degree of conjunction

(disjunction), so that it is of interest to define, according to (10), as a measure of this proximity, the following errors:

$$EAS_{2+1}(c) := \int_0^1 dt_1 \int_0^1 dt_2 \int_0^1 dt_3 \left\{ \left(\frac{1}{3} t_1 \Delta \frac{1}{3} t_2 \Delta \frac{1}{3} t_3 \right) - \left[\frac{1}{3} t_1 \Delta \frac{2}{3} \left(\frac{1}{2} t_2 \Delta \frac{1}{2} t_3 \right) \right] \right\} dt_3,$$

$$EAS_{3+1}(c) := \int_0^1 dt_1 \int_0^1 dt_2 \int_0^1 dt_3 \int_0^1 dt_4 \left\{ \left(\frac{1}{4} t_1 \Delta \frac{1}{4} t_2 \Delta \frac{1}{4} t_3 \Delta \frac{1}{4} t_4 \right) - \left[\frac{3}{4} \left(\frac{1}{3} t_1 \Delta \frac{1}{3} t_2 \Delta \frac{1}{3} t_3 \right) \Delta \frac{1}{4} t_4 \right] \right\} dt_4,$$

$$EAS_{2+2}(c) := \int_0^1 dt_1 \int_0^1 dt_2 \int_0^1 dt_3 \int_0^1 dt_4 \left\{ \left(\frac{1}{4} t_1 \Delta \frac{1}{4} t_2 \Delta \frac{1}{4} t_3 \Delta \frac{1}{4} t_4 \right) - \left[\frac{1}{2} \left(\frac{1}{2} t_1 \Delta \frac{1}{2} t_2 \right) \Delta \frac{1}{2} \left(\frac{1}{2} t_3 \Delta \frac{1}{2} t_4 \right) \right] \right\} dt_4.$$

Figure 4 depicts the errors in the associative law as a function of the conjunction degree. The average absolute errors of the associative law are

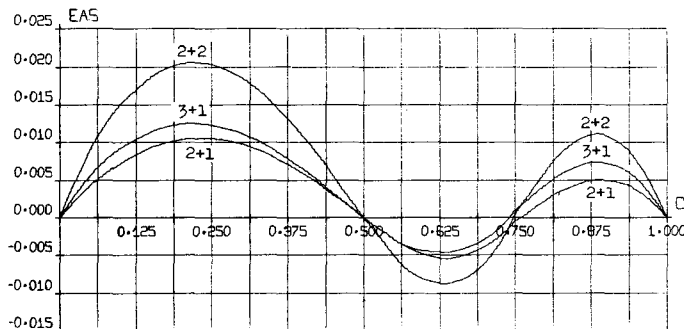

Fig. 4

$$\overline{EAS}_{2+1} := \int_0^1 |EAS_{2+1}(c)| dc = 0.00516,$$

$$\overline{EAS}_{3+1} := \int_0^1 |EAS_{3+1}(c)| dc = 0.00612,$$

$$\overline{EAS}_{2+2} := \int_0^1 |EAS_{2+2}(c)| dc = 0.01006.$$

The values obtained are indeed small. In addition, it can be shown that the values of the errors remain nearly constant even when the weight values are

changed. Therefore, in practically all applications, errors in the associative law can be tolerated. Consequently, in all expressions with the same operation (Δ or ∇) the parantheses can be left out, providing that the weight factors within the parantheses are multiplied by the weight factor in front of them (for example, $a_1(a_2(a_3 t_1 \nabla b_3 t_2) \nabla b_2 t_3) \nabla b_1 t_4 \approx a_1 a_2 a_3 t_1 \nabla a_1 a_2 b_3 t_2 \nabla a_1 b_2 t_3 \nabla b_1 t_4$). Two associative structures represented by different arbitrary trees with the same number of peripheral vertices are nearly equivalent, if they have equal weight products along paths leading from a particular vertex to the root of the tree, for all corresponding peripheral vertices.

2. *Distributivity.* For degrees of truth $t_1, t_2, t_3 \in I$ and weights $a_1, b_1, a_2, b_2 \in I (a_1 + b_1 = a_2 + b_2 = 1)$ the law of distribution is valid in the following form

$$a_1 t_1 \Delta b_1 (a_2 t_2 \nabla b_2 t_3) = a_2 (a_1 t_1 \Delta b_1 t_2) \nabla b_2 (a_1 t_1 \Delta b_1 t_3) + \varepsilon_{dis}(a_1, a_2, t_1, t_2, t_3, c)$$

$$a_1 t_1 \nabla b_1 (a_2 t_2 \Delta b_2 t_3) = a_2 (a_1 t_1 \nabla b_1 t_2) \Delta b_2 (a_1 t_1 \nabla b_1 t_3) + \varepsilon_{dis}(a_1, a_2, t_1, t_2, t_3, 1-d).$$

On the basis of (1) it is easily verified that for $c \in \{0, 1/2, 1\}$, $\varepsilon_{dis} = 0$. The error in the law of distribution in case of equal weights

$$EDIS(c) := \int_0^1 dt_1 \int_0^1 dt_2 \int_0^1 \varepsilon_{dis}\left(\frac{1}{2}, \frac{1}{2}, t_1, t_2, t_3, c\right) dt_3$$

is shown in Fig. 5. The average absolute error of the law of distribution is

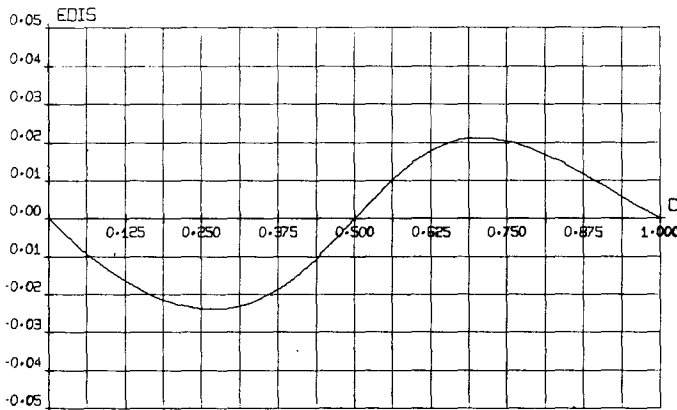

Fig. 5

$$\overline{EDIS} := \int_0^1 |EDIS(c)| dc = 0.01439$$

and it remains nearly constant even in case of different weights.

3. *Idempotency.* For the degree of truth s and weights W_1, \dots, W_n on the basis of (1) and (2) it follows that

$$W_1 s \Delta \dots \Delta W_n s = s, \quad W_1 s \nabla \dots \nabla W_n s = s, \quad n > 1.$$

4. *Commutation.* Due to reasons explained earlier in the text the motive for introducing unequal weights was to make the commutative law invalid. Consequently, the commutative law holds only in case of equal weights, so that for $t_1 + t_2 \neq 0$ and $t_1 \neq t_2$ the following equivalence is valid

$$(W_1 t_1 \Delta W_2 t_2 = W_1 t_2 \Delta W_2 t_1, \quad W_1 t_1 \nabla W_2 t_2 = W_1 t_2 \nabla W_2 t_1) \Leftrightarrow W_1 = W_2 = 1/2.$$

5. *De Morgan's laws.* These laws in *ECL* have the following form

$$(11) (W_1 t_1 \Delta \dots \Delta W_n t_n)' = W_1 t_1' \nabla \dots \nabla W_n t_n' + \varepsilon_{DM}(W_1, \dots, W_n; t_1, \dots, t_n; c)$$

$$(W_1 t_1 \nabla \dots \nabla W_n t_n)' = W_1 t_1' \Delta \dots \Delta W_n t_n' + \varepsilon_{DM}(W_1, \dots, W_n; t_1, \dots, t_n; 1-d)$$

where, for $c \in \{0, 1/2, 1\}$, $\varepsilon_{DM} = 0$. In addition, the average value of the error ε_{DM} in case of equal weights is zero.

Proof. In classical continuous logic, for $c = 0$ and $c = 1$, $\varepsilon_{DM} = 0$. For $c = 1/2$ it follows that $\varepsilon_{DM} = 0$ from $1 - \sum_{i=1}^n W_i t_i = \sum_{i=1}^n W_i (1 - t_i)$. From (6) and (11) the average value of the error is obtained as

$$\begin{aligned} \bar{\varepsilon}_{DM}(c) &:= \int_0^1 dt_1 \cdots \int_0^1 (1 - M_n^{[rn]}(t_1, \dots, t_n)) dt_n \\ &\quad - \int_0^1 dt_1 \cdots \int_0^1 M_n^{[rn]}(1-t_1, \dots, 1-t_n) dt_n \\ &= 1 - \bar{M}_n^{[rn]} - \bar{M}_n^{[rn]} = 0, \quad r_n = C_n^{-1}(c), \quad QED. \end{aligned}$$

The average absolute error of DE MORGAN'S laws in case of equal weights is given by

$$EDM_n(c) := \int_0^1 dt_1 \cdots \int_0^1 \left| \varepsilon_{DM}\left(\frac{1}{n}, \dots, \frac{1}{n}; t_1, \dots, t_n; c\right) \right| dt_n$$

satisfies the condition

$$EDM_n\left(\frac{1}{2} - a\right) = EDM_n\left(\frac{1}{2} + a\right), \quad 0 \leq a \leq \frac{1}{2},$$

and is shown in Fig. 6 for $n = 2, 3, 4$. The average error of DE MORGAN'S laws in *ECL* is

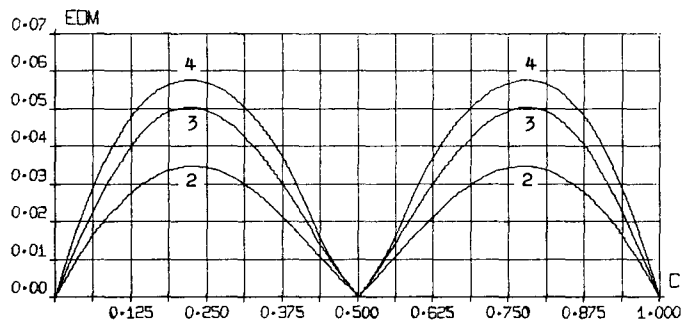

Fig. 6

$$\begin{aligned} \overline{EDM}_n &= \int_0^1 EDM_n(c) dc = 0.02211 (n=2) \\ &= 0.03145 (n=3) \\ &= 0.03719 (n=4) \end{aligned}$$

and it remains nearly constant even in case of unequal weights.

6. *The identity and zero element.* The adjustable degree of conjunction (disjunction) was introduced into *ECL* with the objective to eliminate the identity and zero elements for the operations Δ and ∇ . The resulting properties of the operations Δ and ∇ are shown in Figs. 7 and 8. In Fig. 7, the left-hand family of curves is determined from

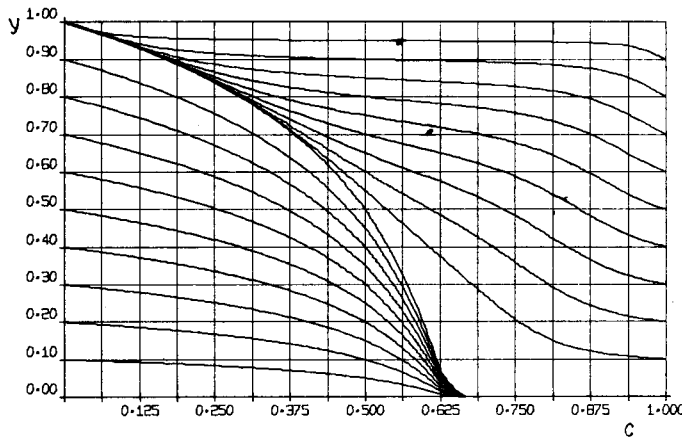

Fig. 7

$$y = \frac{1}{2} p \Delta^c \frac{1}{2} 0 = \frac{1}{2} p \nabla^{1-c} \frac{1}{2} 0, \quad p = 0, 0.1, \dots, 1$$

while the right-hand family of curves is determined from

$$y = \frac{1}{2} p \Delta^c \frac{1}{2} 1 = \frac{1}{2} p \nabla^{1-c} \frac{1}{2} 1, \quad p = 0, 0.1, \dots, 1.$$

Fig. 8 depicts the family of curves

$$y = \frac{1}{2} x \Delta^c \frac{1}{2} x' = \frac{1}{2} x \nabla^{1-c} \frac{1}{2} x', \quad c \in \lambda,$$

which illustrate the essential properties of the operations Δ and ∇ and can be used for computing quasi-conjunctions and quasi-disjunctions of more than one variable [8].

7. *Absorption.* For degrees of truth $t, t_2 \in I$ and weights $a_1, b_1, a_2, b_2 \in I (a_1 + b_1 = a_2 + b_2 = 1)$ the law of absorption has the following form

$$(12) \quad \begin{aligned} a_1 t_1 \Delta b_1 (a_2 t_1 \nabla b_2 t_2) &= t_1 + \varepsilon_{abs}(a_1, a_2, t_1, t_2, c) \\ a_1 t_1 \nabla b_1 (a_2 t_1 \Delta b_2 t_2) &= t_1 + \varepsilon_{abs}(a_1, a_2, t_1, t_2, 1-d) \end{aligned}$$

where, for $c \in \{0, 1\}$, $\varepsilon_{abs} = 0$. Due to the previously described properties of quasi-conjunctions and quasi-disjunctions it follows that the law of absorption

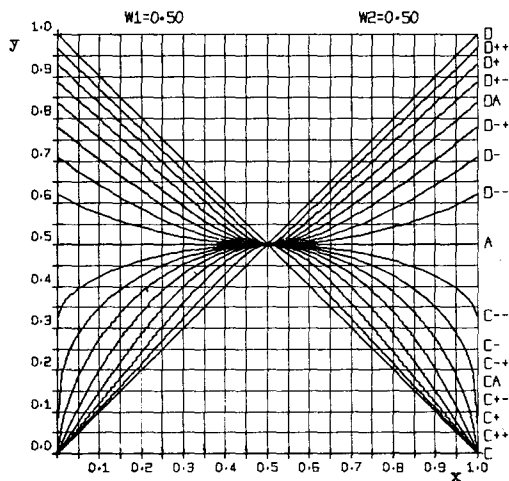

Fig. 8

error is essentially dependent upon the values of the weights a_1 and a_2 . The average absolute error for the law of absorption

$$EABS(a_1, a_2, c) := \int_0^1 dt_1 \int_0^1 |\varepsilon_{abs}(a_1, a_2, t_1, t_2, c)| dt_2,$$

whose maximum can be closely approximated with

$$EABS\left(a_1, a_2, \frac{1}{2}\right) = b_1 b_2 / 3 = (1 - a_1)(1 - a_2) / 3,$$

is shown in Fig. 9 for $a_1 = 0.5, a_2 = 0.25, 0.5, 0.75$.

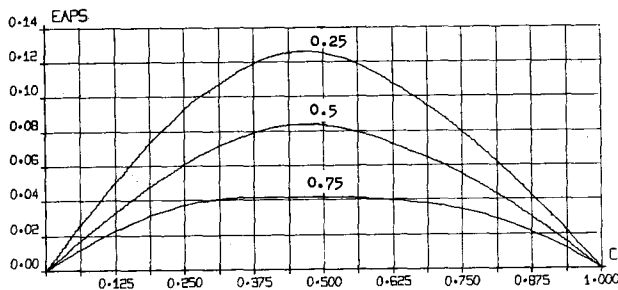

Fig. 9

The average error of the law of absorption is

$$\overline{EABS}(a_1, a_2) := \int_0^1 EABS(a_1, a_2, c) dc$$

and is shown in Table 2.

Table 2 $\overline{EABS}(a_1, a_2)$

$a_1 \backslash a_2$	0.75	0.5	0.25
0.75	0.0144	0.0304	0.0497
0.5	0.0258	0.0524	0.0831
0.25	0.0405	0.0781	0.1195

Starting from a parabolic approximation

$$EABS(a_1, a_2, c) \approx \frac{4}{3} (1 - a_1) (1 - a_2) c (1 - c)$$

it follows that

$$\overline{EABS}(a_1, a_2) \approx \frac{2}{9} (1 - a_1) (1 - a_2)$$

$$\overline{EABS} = \int_0^1 da_1 \int_0^1 \overline{EABS}(a_1, a_2) da_2 \approx \frac{1}{18} = 0.0505.$$

Discussion. The basic laws of *ECL* described in the text are applied to expertly estimated degrees of truth of corresponding statements, which are therefore known only to a limited degree of exactness. On the basis of results of experimental psychology (for example, [9, 10]) and experience gained through practical application of *ECL*, it follows that the absolute value of the error for an expert estimation of the degree of truth can be expected on the interval I to within 15% and in exceptional cases even more. From this fact it can be concluded that the absolute errors of the laws of associativity, distribution and idempotency, which are on the average lesser than 2% can be neglected so that, from the practical point of view, these laws are completely valid. A similar conclusion can be extended to De Morgan's laws, even though the average absolute errors are somewhat greater (2% to 4%). As far as the law of absorption is concerned, the error can be made arbitrarily small according to need (on the average 5%). However, as will be shown further on, the law of absorption has a dominant application in *ECL* in the region of large errors, that is, it is used for the controlled partial absorption of a given degree of truth.

5. FUNCTIONS IN EXTENDED CONTINUOUS LOGIC

In this section only those *ECL* functions which are used most often in the synthesis of complex criteria are considered. These are functions obtained by superposition of quasi-conjunctions, quasi-disjunctions and negations. More specifically, the only functions of interest are some selected functions of one or two variables, and of two-variable functions, only those which are equal to zero at the point (0, 0) and unit at (1, 1). Since the law of associativity holds,

functions with a greater number of variables can be realized by superposition of one-variable and two-variable functions and with quasi-conjunctions and quasi-disjunctions of variables.

It is suitable for the realization of complex criteria to adopt the following classification of *ECL* functions. Functions for which all independent variables take on values from a finite set we shall call „discrete functions”, while functions for which the values of all independent variables belong to the whole interval I we shall call „continuous functions”. Functions for which some independent variables take on values from finite sets and some from the whole interval I we shall call „hybrid functions”. In the following text we shall demonstrate the realization of the most significant representatives of these three classes of *ECL* functions, stressing the fact that the problem of realization of these functions is equivalent to the problem of finding logic formulas from an arbitrarily given function, and this problem has already been solved in classical continuous logic [5].

5.1. Class of discrete functions

In the class of discrete functions the use of functions with binary independent variables is dominant; this group of functions consists of five two-variable functions shown in Table 3.

Table 3

x	y	z_1	z_2	z_3	z_4	z_5
0	0	0	0	0	0	0
0	1	0	0	a	a	1
1	0	0	b	b	1	1
1	1	1	1	1	1	1

In addition to the realization of these functions by superposing conjunctions, disjunctions and negations in the form

$$\begin{aligned}
 z_1 &= x \wedge y, \\
 z_2 &= x \wedge [y \vee (b \wedge y')], \\
 z_3 &= (a \wedge x' \wedge y) \vee (b \wedge x \wedge y') \vee (x \wedge y), \\
 z_4 &= (a \wedge x' \wedge y) \vee x, \\
 z_5 &= x \vee y \\
 &(0 < a < 1, \quad 0 < b < 1),
 \end{aligned}
 \tag{13}$$

other analytical forms of these functions are possible in *ECL* which, from a practical viewpoint, are more adequate since they are based on the use of a lesser number of elementary operations. This problem, to be considered presently, is in essence equivalent to the switching function minimization problem.

Function $z_1(x, y)$ represents a conjunction and in *ECL* it can be equivalently realized with any function $f \in \{C^{-+}, CA, C^{+-}, C^+, C^{++}, C\}$ even when using arbitrary weights, because in that case weighted power means are used with the parameter $r < 0$, where a mean is equal to zero if any of the quantities being averaged is equal to zero.

We shall call function $z_2(x, y)$ the „discrete function of conditioned value” since x plays the part of a condition which if not fulfilled ($x=0$) results in a zero value for the function, while in the case when it is fulfilled ($x=1$) the value of the function depends on y . The minimal form of this function is

$$(14) \quad z_2 = x \wedge [b x \nabla^{1/2} (1-b) y]$$

Function $z_3(x, y)$, depending on the values for a and b , covers the quasi-disjunction region and a part of the quasi-conjunction region. Its minimal form is

$$(15) \quad z_3 = W_1 x \nabla^d W_2 y$$

where

$$W_1 = b^r, \quad W_2 = a^r, \quad r = D_2^{-1}(d), \quad r > 0,$$

and the disjunction degree is determined from

$$(16) \quad a^{D_2^{-1}(d)} + b^{D_2^{-1}(d)} = 1$$

For every $a, b \in (0, 1)$ equation (16) can be solved for d . However, instead of solving it numerically, in practice it is easier to solve it approximately with the objective to select the approximate solution from the set λ . The algorithm for the approximate solution is shown in Fig. 10 in which both families of curves

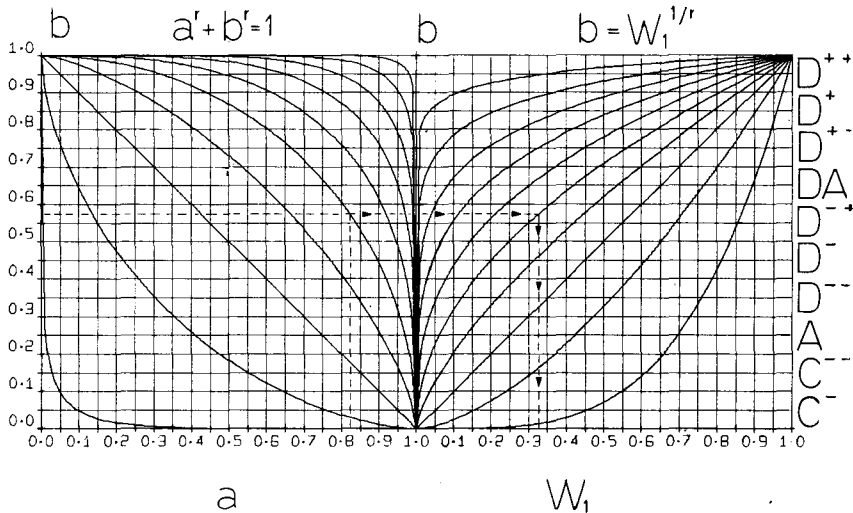

Fig. 10

from top to bottom are determined for the value of the parameter r which is used in the operations $D^{++}, D^+, D^{+-}, DA, D^{-+}, D^-, D^{--}, A, C^{--}, C^-$ (Table 1, $n=2$). The desired pair a_0, b_0 is approximated by the nearest pair a, b

which lies on one of the curves of the family $a^r + b^r = 1$ (which determines d), and the corresponding values W_1 and $W_2 = 1 - W_1$ are found then using the family $b = W_1^{1/r}$ (for example, for $a = 0.82$ and $b = 0.575$ from Fig. 10 it follows that the operation is D^- and that $W_1 = 0.325$, $W_2 = 0.675$).

Function $z_4(x, y)$ represents an asymmetrical quasi-disjunction whose minimal form is

$$(17) \quad z_4 = x \vee [(1-a)x \nabla^{1/2} ay].$$

Function $z_5(x, y)$ is a disjunction and in *ECL* it has no alternative representative forms.

The analytical forms of the functions (14), (15) and (17) are simpler than the initial analytical forms in (13). The proof that (14), (15) and (17) are minimal forms is evident: they are realized with only one, and if not possible, then with two operators.

5.2. Class of continuous functions

In the class of continuous functions we shall first describe the basic functions of one variable. In addition to negation $x \mapsto 1-x$, the attenuation function

$$(18) \quad y_1 = ax = ax \nabla^{1/2} (1-a) 0$$

is of interest, as well as the function

$$(19) \quad y_2 = (1-a)x \Delta^c ax'$$

whose properties can be adjusted with the parameters c and a . For $c = 1/2$ function (19) enables a wide choice of linear transformations of the degree of truth x as well as the generation of a constant (for $a = c = 1/2$ it follows that $y_2 = 1/2$), while in the cases $c \rightarrow 0$ and $c \rightarrow 1$ this function displays filtering properties, emphasizing truth degrees from a certain interval of values (compare Fig. 8)

In the group of functions of two variables, in addition to the basic logic functions of quasi-conjunction and quasi-disjunction, an often-used function in practice is what will be called „partial absorption” defined by

$$(20) \quad z_6 = W_2 x \Delta^c (1 - W_2) [W_1 x \nabla^{1/2} (1 - W_1) y].$$

A comparison of (20) and (12) shows that (20) represents a modification of the absorption function (12) derived by introducing the arithmetic mean $\nabla^{1/2}$. The partial absorption function performs, to a variable degree determined by a suitable choice of values for parameters W_1 , W_2 and c , the partial absorption of variable y by variable x . This function is used when it is necessary to express an unequal relationship between the variables x and y ; for example, by using conjunction degrees for which $C_2^{-1}(c) < 0$, for $x = 0$ it follows that $z_6 = 0$, and for $y = 0$ it follows that $W_1 x \leq z_6 < x$.

If $c = 0$ is inserted into (20) the often-used continuous form of the asymmetric quasi-disjunction (17) is obtained:

$$\begin{aligned} z_6 &= x \vee [W_1 x \nabla^{1/2} (1 - W_1) y] = x & (x \geq y), \\ &= W_1 x + (1 - W_1) y & (x \leq y). \end{aligned}$$

5.3. Class of hybrid functions

For hybrid functions of two variables one variable is discretely adjustable, while the other is continuously adjustable. The most important representative of this class is the „hybrid function of conditioned value”

$$z_7 = y \cdot (x = 1) \\ = ay \quad (x = 0), \quad 0 < a < 1,$$

where, similar to the discrete function of conditioned value, x represents a binary condition which determines the degree of influence that variable y has on the value of the function z_7 . The expression for this function in *ECL* is

$$(21) \quad z_7 = (x \wedge y) \vee \{x' \wedge [ay \nabla^{1/2} (1 - a)x]\}.$$

Since for $x \in \{0, 1\}$ we have

$$x' \wedge [ay \nabla (1 - a)x] = x' \wedge [ay \nabla (1 - a)0]$$

from (18) and (21) it follows that

$$z_7 = (x \wedge y) \vee (x' \wedge ay).$$

During the synthesis of complex criteria it is practical to use the block diagram representation of *ECL* functions, with which some of the previously mentioned functions are shown in Fig. 11.

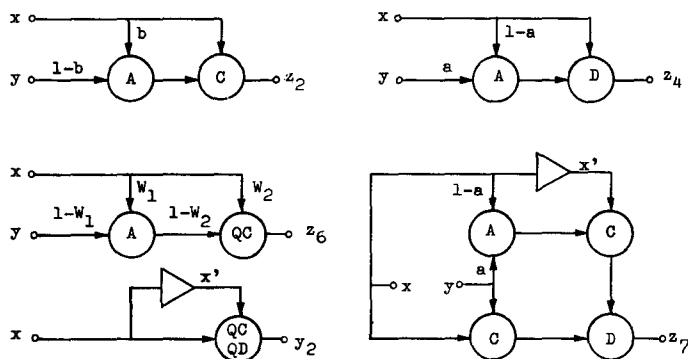

Fig. 11

6. LOGIC POLARIZATION OF COMPLEX CRITERIA

Let there be given k elementary criteria which comprise a complex unique criterion and let the elementary effectivenesses E_1, \dots, E_k ($k \geq 2$) be known. The mapping $L: I^k \rightarrow I$, with which the resulting global effectiveness $E = L(E_1, \dots, E_k)$ is determined, is realized by taking into account the logic relationships among the elementary effectivenesses. In the following text we shall consider the main components in the process of selecting logic dependences in *ECL*.

Definition 4. *Logic polarization of a complex criterion is the set of conditions with which the type and intensity of logic dependences between elementary effectivenesses are defined in ECL.*

Definition 5. A simple logic polarization of a given complex criterion is a polarization which can be expressed in terms of one of the basic ECL operations: conjunction, quasi-conjunction, conjunctive-disjunctive undetermination, quasi-disjunction or disjunction.

Definition 6. A complex logic polarization of a given criterion is every logic polarization which is expressed by a superposition of basic ECL operations.

Therefore, there are three possibilities of simple logic polarization of complex criteria:

- the criterion is polarized conjunctively, i. e. a certain degree of coincidence is required in the fulfilment of all elementary criteria
- the criterion is polarized disjunctively, i. e. at least one of the elementary criteria should be fulfilled to a sufficient degree
- the complex criterion is neither conjunctively nor disjunctively polarized.

The algorithm for choosing the type and intensity of polarization for simple logic polarizations of complex criteria is shown in Fig. 12. This algorithm is

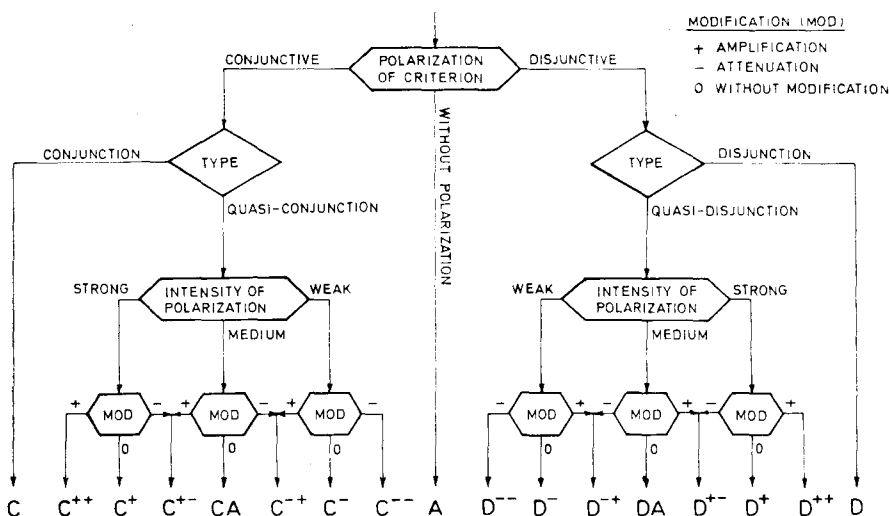

Fig. 12

widely used in ECL since complex logic polarization is realized by superposition of basic logic operations, and this means that some form of simple logic polarization is used in parts of the complex criterion. For this reason the choice of type and intensity of complex logic polarizations reduces to choosing an adequate combination of simple logic polarizations, i. e. multiple applications of the algorithm in Fig. 12.

7. SYNTHESIS OF EFFECTIVENESS CRITERIA FOR COMPLEX SYSTEMS

The process of synthesizing a global effectiveness criterion with which the global effectiveness $E = g(x_1, \dots, x_n)$ is calculated for a given system S , from the known values of components for evaluation x_1, \dots, x_n , is proposed in the form of an algorithm consisting of the following stages:

- I Definition of the set of components for evaluation $x = (x_1, \dots, x_n)$.
- II Formulation of the elementary effectiveness criteria $g_i: \mathbf{R}_i \rightarrow I$, $\mathbf{R}_i \subset \mathbf{R}$, $i = 1, \dots, n$ through which the elementary effectivenesses $E_i = g_i(x_i)$, $i = 1, \dots, n$ are calculated from known values x_1, \dots, x_n .
- III Application of sentential algebra in ECL for realization of the mapping $L: I^n \rightarrow I$ with which the resultant global system effectiveness $E = L(E_1, \dots, E_n)$ can be calculated on the basis of known elementary effectivenesses E_1, \dots, E_n .
- IV Formulation of the global effectiveness criterion $g: \mathbf{R}_1 \times \dots \times \mathbf{R}_n \rightarrow I$ in compact form $E = g(x_1, \dots, x_n) = L(g_1(x_1), \dots, g_n(x_n))$.

The initial stage in the synthesis of a global effectiveness criterion consists of defining the set of components for evaluation. It is essential that all system performance indicators which influence the ability of a system to attain the desired goals are expressed through such components for evaluation. At the same time, components for evaluation must not be redundant quantities, that is, quantities which express the same properties of a system in different ways which unintentionally and uncontrollably increases the degree of this properties' influence on the global system effectiveness.

In the next stage, the elementary effectiveness criteria are synthesized. For each component for evaluation, on the basis of its specific properties and the requirements of the given system, a sequence of characteristic values $x_{i1}, x_{i2}, \dots, x_{ik_i}$ ($x_{i1} < x_{i2} < \dots < x_{ik_i}$, $k_i \geq 2$, $i = 1, \dots, n$) is defined and corresponding effectivenesses $e_{i1}, e_{i2}, \dots, e_{ik_i}$ ($e_{ij} \in I$, $j = 1, \dots, k_i$), $i = 1, \dots, n$ are associated to each value. In this way, elementary effectiveness criteria are realized as polygonal approximations:

$$\begin{aligned}
 g_i(x_i) &:= e_{i1} && (x_i \leq x_{i1}) \\
 &= e_{ij} + (x_i - x_{ij})(e_{i(j+1)} - e_{ij}) / (x_{i(j+1)} - x_{ij}) && (x_{ij} \leq x_i \leq x_{i(j+1)}), \quad j = 1, \dots, k_i - 1 \\
 &= e_{ik_i} && (x_i \geq x_{ik_i}), \quad i = 1, \dots, n.
 \end{aligned}$$

In practice it is often necessary to define the characteristic values x_{i1}, \dots, x_{ik_i} as a sequence of integers $0, 1, \dots, k_i - 1$ which code the different quality levels for those components for evaluation which are of the qualitative type.

The mapping $L: I^n \rightarrow I$, realized in the third stage, represents a sentential formula for computing the truth value of a corresponding complex statement consisting of n elementary statements of known truth values. In practice n ranges from ten to several hundred. A complex statement consisting of such a large number of elementary statements is best realized in stages, by applying a corresponding aggregation procedure. To this end it is first necessary to decompose system S into subsystems which, for the needs of complex criteria synthesis, are specifically defined in the following manner.

Definition 7. *A subsystem of a system S (in the sense of effectiveness criterion decomposition) is every subset of components for evaluation which are mutually related to a greater degree, so that they can be considered as a whole, independently of the values of other components for evaluation. A subsystem effectiveness can be associated to it as the truth value of the statement „the subsystem completely meets all given requirements“.*

The main consequence of this definition is the possibility to form a new complex subsystem by aggregating a number of simpler subsystems. Certainly, subsystems in the sense of effectiveness criterion decomposition can, though not necessarily, coincide with subsystems obtained through various procedures of structural or functional decomposition of a given system.

In a multilevel subsystem aggregation process the components for evaluation form the initial (first) level with $n_1 = n$ elementary effectivenesses. On the second level, subsystems are formed as partition of the set of components for evaluation, i. e. as a family of n_2 subsets $x_1^{(2)}, \dots, x_{n_2}^{(2)}$ ($n_2 < n_1$) which fulfils the conditions

$$x = x_1^{(2)} \cup x_2^{(2)} \cup \dots \cup x_{n_2}^{(2)}, \quad x_i^{(2)} \cap x_j^{(2)} = \emptyset \quad (i \neq j).$$

With the system objectives in mind, the objectives of every subsystem and the subsystem effectiveness criteria can be formed. Since the elementary effectiveness criteria and the elementary effectivenesses do not change by the formation of subsystems, for realizing the subsystem effectiveness criteria is necessary only to form the mappings $L_i^{(2)}: I^{m_i} \rightarrow I$, $i = 1, \dots, n_2$, with which on the basis of elementary effectivenesses of each subsystem the subsystem effectivenesses $E_i^{(2)}$, $i = 1, \dots, n_2$ can be computed. The number of elementary effectivenesses m_i within a particular subsystem is chosen to be sufficiently small number (most often $2 \leq m_i \leq 5$), so that there is no difficulty in determining the logic polarization of the subsystem criterion and the corresponding sentential formula in *ECL*.

On the third level, the subsystems are aggregated, so that the subsystem effectivenesses $E_i^{(2)}$, $i = 1, \dots, n_2$ have the same function which the elementary effectivenesses had on the second level. By including related second-level subsystems into more complex third-level subsystems, n_3 new subsystems are obtained ($n_3 < n_2$). Realization of subsystem effectiveness criteria leads, as in the previous case, to an analysis and the adoption of a logic polarization for the observed criteria, and then to the formulation of a sequence of mappings $L_i^{(3)}$, $i = 1, \dots, n_3$ and the computation of all third-level subsystem effectivenesses $E_i^{(3)}$, $i = 1, \dots, n_3$. This process is then repeated on higher levels, during which the number of generated subsystems decreases, while their complexity increases. On the final highest aggregation level a global effectiveness of a complete system is generated, which completes the synthesis of a complex criterion.

REFERENCES

1. D. S. MITRINOVIĆ, P. M. VASIĆ: *Sredine*. Matematička biblioteka, sv. 40, Beograd 1969.
2. J. J. DUJMOVIĆ: *Weighted conjunctive and disjunctive means and their application in system evaluation*. These Publications № 461—№ 497 (1974), 147—158.
3. J. J. DUJMOVIĆ: *Two integrals related to means*. These Publications № 412—№ 460 (1973), 231—232.
4. С. А. ГИНЗБУРГ: *Математическая непрерывная логика и изображение функций*. Москва, 1968.
5. R. A. MC NAUGHTON: *A theorem about infinite-valued sentential logic*. J. Symb. Logic 16, №. 1 (1951), 1—13.
6. S. MC LANE, G. BIRKHOFF: *Algebra*. New York 1968.
7. А. И. МАЛЦЕВ: *Алгебраические системы*. Москва 1970.
8. J. J. DUJMOVIĆ: *Graphic approach to weighted conjunctive and disjunctive means calculation*. Same Publications № 535 (1975), 183—188.
9. G. A. MILLER: *The magical number seven plus or minus two; some limits on our capacity for processing information*. Psychol. Rev. 63 (1956), 81—97.
10. T. B. SHERIDAN, W. R. FERRELL: *Man-machine systems / Information, control and decision models of human performance*. Cambridge (U.S.A) 1974.